

The Digby Series

BLWD - Wrap

Project

Date

Part

Type

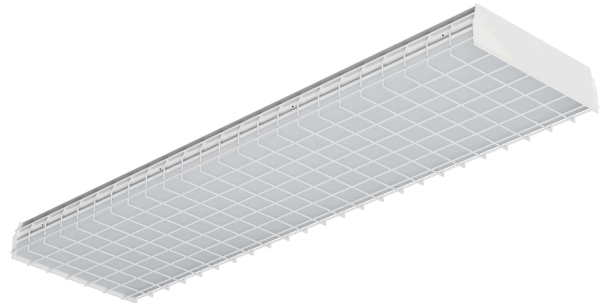

About The Digby Series

The BLWD is an LED wrap fixture designed for surface and suspended mounting. It is well suited for use in office spaces, hallways, and applications where existing luminaires can be replaced with a new energy efficient LED fixture while covering existing ceiling lines and unpainted areas.

Specifications

Supported Voltage	120-277V, 347V, 120-347V, 480V
Available Sizes	4'
Lifetime	L70 of 230,000+ hours, L90 of 70,000+ hours
Operating Temperature	-20°C/+25°C
Lumens	Lumen output ranging from 2L (2000lm) to 6L (6000lm)
CCT	2700K, 3000K, 3500K, 4000K, 5000K, 6500K
CRI	80+ standard, 90+ and 95+ available
Dimming	0-10V Standard
Mounting	Holes provided for V-hangers, S-hook chain-mounting, or aircraft cables

Approvals

- ETL Listed
- Dry and Damp Environment Rated
- Designed and Manufactured in Canada

Warranty

- 5 Year Comprehensive, 10 Year LED

The Digby Series

BLWD - Wrap

Please use the diagram to the right as an example of a completed order code. If you need any assistance contact your local sales representative.

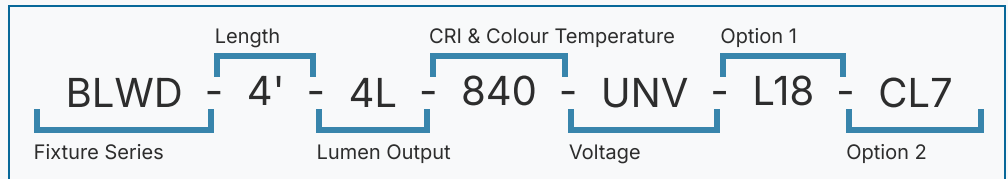

1	2	3	4	5	6	
Series	Size	Lumen Output		CRI	CCT	Voltage
BLWD	4'	2L	2,000lm	8	80	27 2700K UNV 120-277V
		3L	3,000lm	9	90+	30 3000K 347 347V
		4L	4,000lm	1	95+	35 3500K UN3 120-347V
		5L	5,000lm		40	4000K 480 480V
		6L	6,000lm		50	5000K
					65	6500K

Options

Lenses

BLANK | Frosted Acrylic

Cords

W3xx | White 16/3 (Specify Length)

W4xx | Black 16/3 (Specify Length)

W59xx | White 16/5 (Specify Length)

W*** | Other Options Available*

Key.	Cord Length.	Key	Cord Length
6	6FT	15	15FT
10	10FT	20	20FT

Ex. W406 would be 16/3 Black, 6FT

Motion Sensors

W26 | Photocell Motion Sensor

W57 | Dimming Motion Sensor (dims to 50% when unoccupied)

W53* | On/Off

W8* | High/Low

WX16 | Microwave Dimmable Sensor

W** | Other Options Available*

Dimming

B11 | 0-10V Dimming Leads

B12 | Line Voltage Dimming

B27 | Dim-to-off Driver

B** | Other Options Available*

Wireless Controls

WCAWN | Lutron Athena (Node)

WCAWNS | Lutron Athena (Sensor)

WC10 | Encelium

WC18 | NX Wireless

WC19 | Avi-on

WC22 | JDRF Autonomy

WC31 | Keilton

WCxx | Other Options Available*

Emergency Driver

B17 | UL924 10W Battery Back-up

F8 | UL924 Emergency Relay

Wire Guard

G1 | Heavy Duty White

G5 | Heavy Duty Black

Finish

BLANK | Standard Gloss White

C5 | Matte Black

CUSTOM* | Custom Colour Choice

Packaging

BLANK | Individually Boxed on Pallets

P0 | Bulk Packaging

Mounting

M1 | V-Hangers

M2xx | V-Hanger with Aircraft Loop Cables

M3xx | Y-Toggle Aircraft Cables

M24 | Single Pendant Mount(3/4 Hub)

M** | Other Options Available*

Key.	Aircraft Length.	Key	Aircraft Length
5	5FT	15	15FT
10	10FT	20	20FT

Ex. M305 would be Y-Toggle, 5FT

Warranty

CL7 | 10-Year Comprehensive Warranty Upgrade

Documentation and Resources

All files and resources are available on our website for download. Files and resources are also embedded as links in this document, listed below. Additional files may be available upon request.





Please contact your local sales agent [here](#) or contact sales@bjtake.com for more information.

 [BLWD - Installation Instructions](#)

 [BLWD - Photometry.zip](#)

Certifications and Listings

Certifications that apply to this fixture and its possible configurations are listed here. More information available upon request.

Icon	Description
	ETL Listed
	Wireless Controls Available
	90 and 95+ CRI Options Available
	120-347V(UN3) Available

Usage Applications

This fixture can be used in a variety of applications, and is ideal for the following:

Usage Application
Aisle Lighting
Displays
Grocery Stores
Hospitals
Offices
Retail Stores
Schools
Task Lighting
Suspended
Surface Mount

Warranty Statement

BJ Take products are tested and/or inspected prior to being packaged for shipment and are guaranteed from the day the product is shipped for a period of ten-year LED chip warranty and a five-year comprehensive component warranty. This can be upgraded to a ten-year comprehensive warranty on request.

BLWD 4' Side

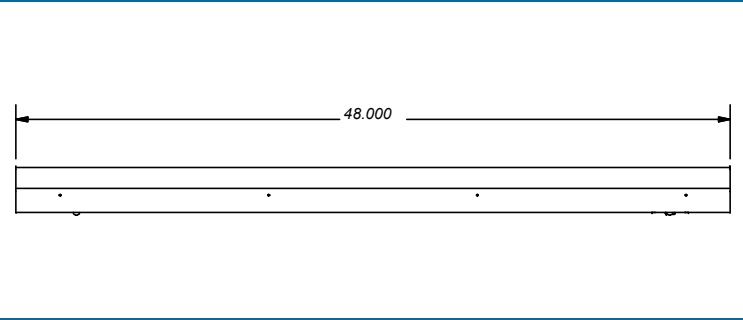

BLWD 4' End

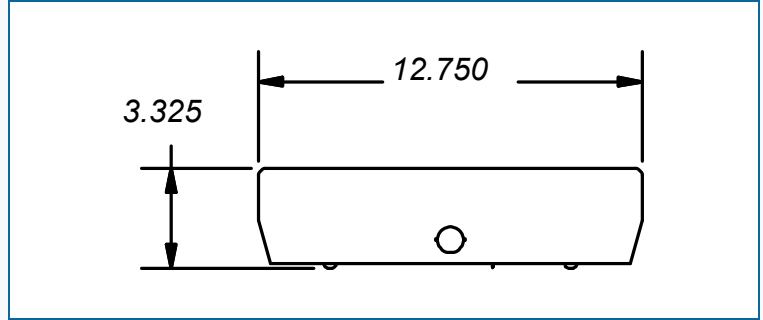

BLWD 4' Top

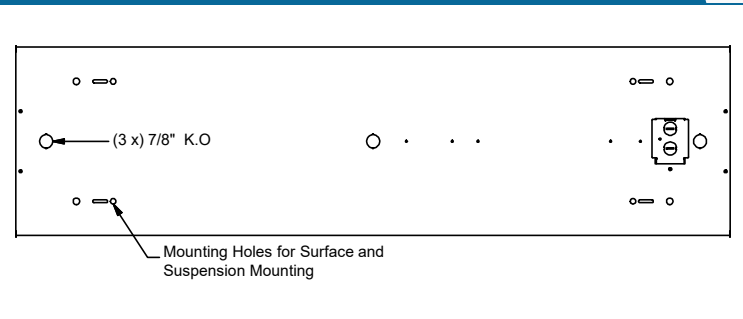

BLR 4' Wattage

Length	Lumen Output	Actual Lumen Output	Wattage	Lumens per Wattage
4'	2	2124	17	123.06
4'	3	3136	24	130.67
4'	4	4148	32	129.63
4'	5	5160	40	129.00
4'	6	6172	48	128.58

- * Drawings not to scale
- * Standard tolerances apply
- * Specifications may change without notice

The Digby Series

BLWD - Wrap

BLWD-4FT-2L-840-L18

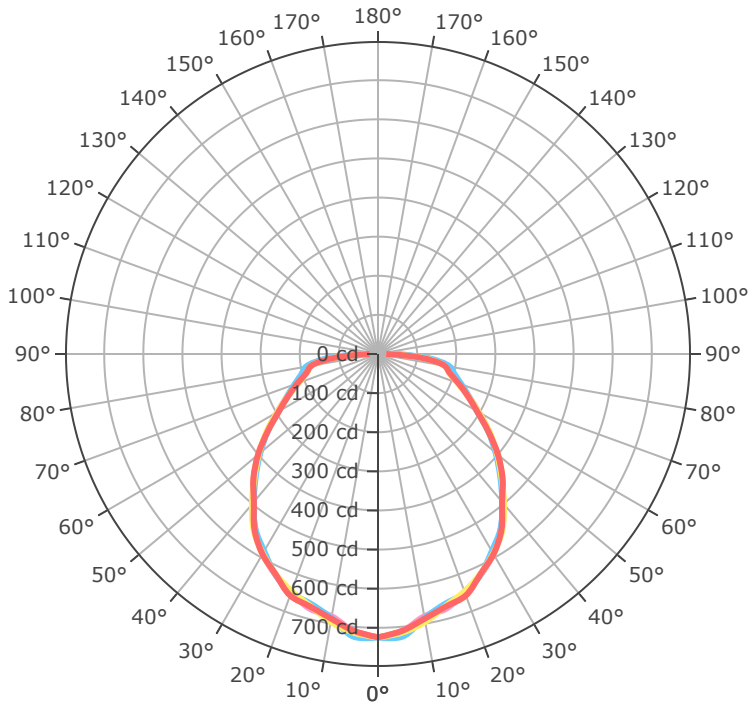

- 0.0°
- 45.0°
- 90.0°
- 135.0°
- 180.0°

Mtg Height	Light Level	Beam Diameter
6.0 ft	20.1 fc	16.1 ft
8.0 ft	11.3 fc	21.5 ft
10.0 ft	7.2 fc	26.9 ft
12.0 ft	5.0 fc	32.3 ft
14.0 ft	3.7 fc	37.7 ft
16.0 ft	2.8 fc	43.1 ft
24.0 ft	1.3 fc	64.6 ft
32.0 ft	0.7 fc	86.1 ft
40.0 ft	0.5 fc	107.7 ft
48.0 ft	0.3 fc	129.2 ft
56.0 ft	0.2 fc	150.7 ft
64.0 ft	0.2 fc	172.3 ft

BLWD-4FT-6L-840-L18

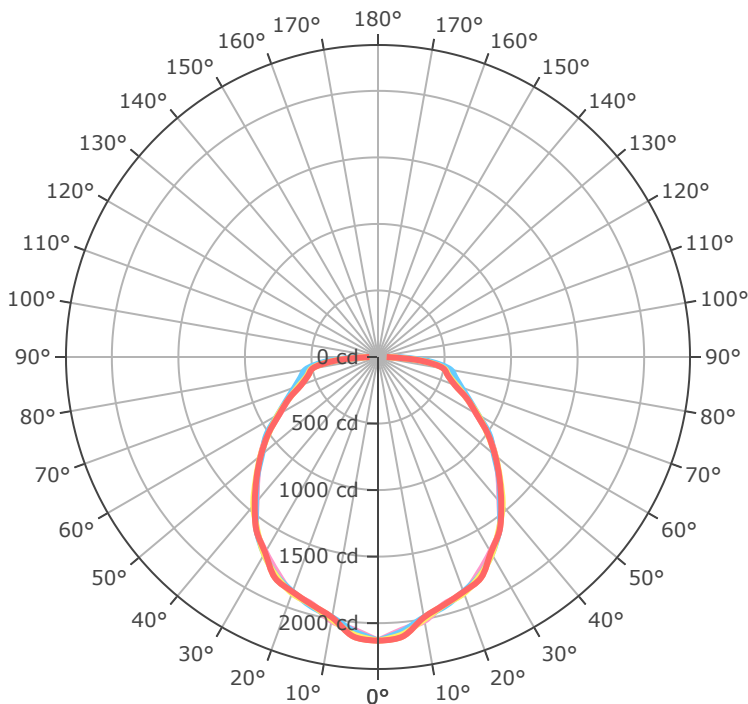

- 0.0°
- 45.0°
- 90.0°
- 135.0°
- 180.0°

Mtg Height	Light Level	Beam Diameter
6.0 ft	59.2 fc	15.9 ft
8.0 ft	33.3 fc	21.2 ft
10.0 ft	21.3 fc	26.5 ft
12.0 ft	14.8 fc	31.8 ft
14.0 ft	10.9 fc	37.1 ft
16.0 ft	8.3 fc	42.4 ft
24.0 ft	3.7 fc	63.5 ft
32.0 ft	2.1 fc	84.7 ft
40.0 ft	1.3 fc	105.9 ft
48.0 ft	0.9 fc	127.1 ft
56.0 ft	0.7 fc	148.2 ft
64.0 ft	0.5 fc	169.4 ft

Emergency Battery Plan - 10W

Emergency Lighting	Solution System Components	System Operation
Option Code 'B17' - UL 924 listed components that are factory installed in the luminaire	UL 924 listed 10-watt battery integral to the luminaire	Loss of normal power is detected by the B17 emergency light solution and the power supply is switched automatically to the 10-watt integral battery pack which powers the emergency LED lighting driver.
	UL 924 listed LED emergency lighting driver integral to the luminaire	The battery pack and emergency LED driver are UL 924 certified to provide a minimum of 90-minutes of emergency lighting.
	Wiring options for both switched and unswitched emergency lighting	

Emergency Lighting Wiring

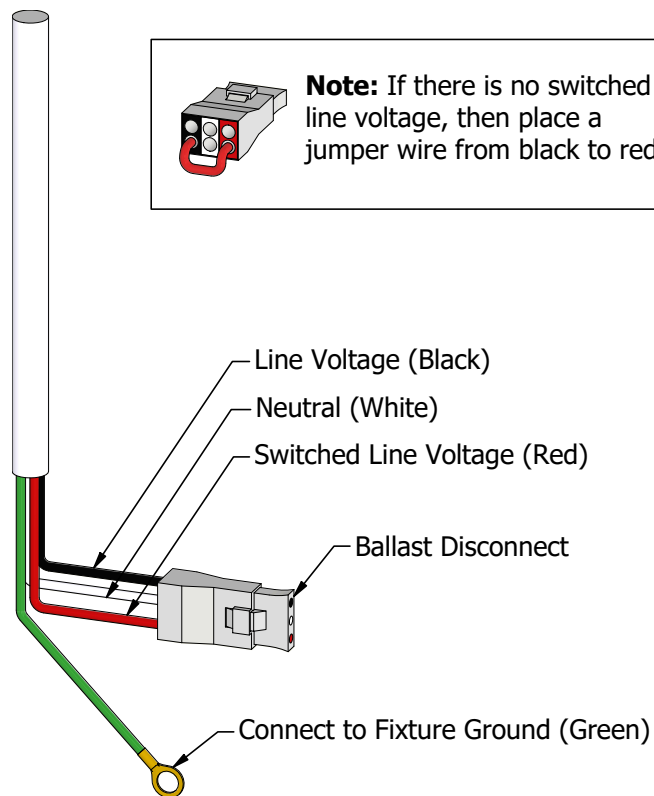

Important Information

More information on emergency lighting options and configurations available on request.

Gallery Information

Below you will find images of relevant products and configurations for the BLWD.

